

- Modular design for vertical stacking assemblies
- Build-in load sensing shuttle valve
- Installation dimensions to ISO 4401:1994 and DIN 24 340-A6

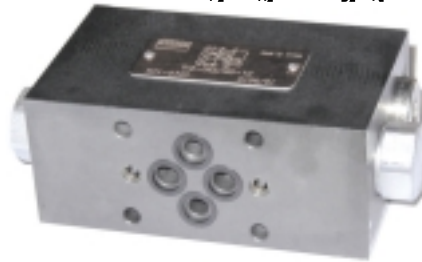
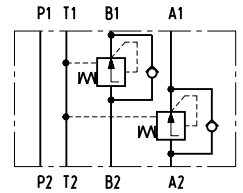
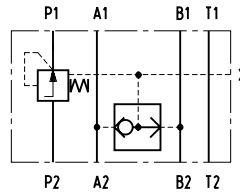

Functional Description

2-Way pressure compensator for meter-in application

The 2-way pressure compensators in meter-in application will maintain a constant pressure difference across the metering edge of the proportional directional valve. In this case, the pressure variations due to loading changes, as well as pump pressure changes are compensated so any increase in pump pressure does not affect the flow. The meter-in compensators may only be used with positive load direction.

Valves TV2-062/M are directly operated 2-way pressure compensators in sandwich plate design. They are designated for load compensation in channel P.

The main parts of these valves are the housing (1), control spool (2), spring (3) and shuttle valve (4). The spring (3) holds the spool in the open position from P2 to P1, provided that the pressure difference between P1 and A (P1 - B) is less than 10 bar. When the pressure difference exceeds the value of 10 bar, the spool shifts against the spring until the desired pressure difference has been restored.

The pressure signal comes through passage (5) from channel P.

The valve body is phosphated, all other parts are zinc coated.

2-Way pressure compensator for meter-out application

In systems with changing load directions, the use of meter-out pressure compensators is required. With respect to the application a valve with pressure compensator installed in one, or in both actuator ports are available.

The pressure compensator is always mounted between the actuator and the proportional directional valve. The valve will maintain the pressure difference between A and T or B and T constant. The flow rate and the flow direction are adjusted by the proportional directional valve. To enable the reverse flow, two by-pass check valves are incorporated into the valve body.

The valve consists of the valve body (1), one or two control spools (2) and poppets of the by-pass check valves (3). If the pump, for example, is connected to port A, the fluid passes to the actuator through a check valve and returns from the actuator through channel B to the proportional directional valve. The pressure difference across the metering edge of the directional valve is maintained at a constant level. This ensures a constant flow rate independent to the load. The pressure difference is controlled by the metering edge (4), its value being determined by spring force (5).

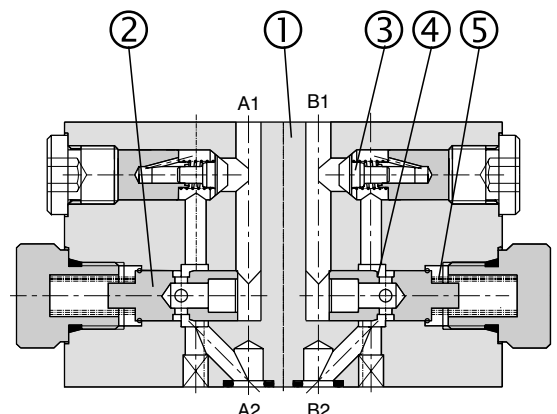
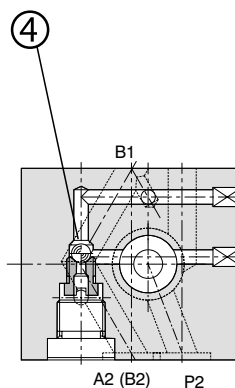
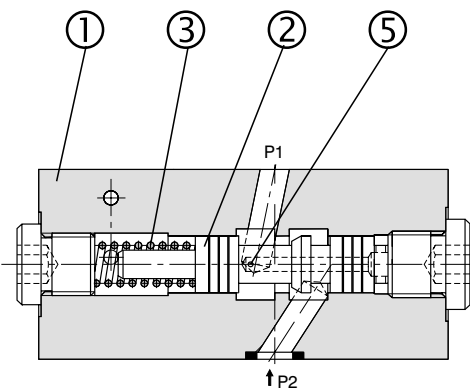

Ordering Code

TV2 - 062/M

Pressure compensator

Nominal size

2-Way pressure compensator

Sandwich plate design

without designation
V

Seals
NBR
FPM (Viton)

A
B
C
D
E
F

Model
Meter-in compensator in channel A
Meter-in compensator in channel B
Meter-in compensator in channels A and B
Meter-out compensator in channels A and B
Meter-out compensator in channel A
Meter-out compensator in channel B

Technical Data

Nominal size	mm	06
Maximum flow	L/min	35
Max. operating pressure	bar	320
Pressure drop on valve Δp	bar	10
Hydraulic fluid	Hydraulic oils of power classes HM, HV to CETOP-RP 91H in viscosity classes ISO VG 32, 46 and 68.	
Maximum degree of fluid contamination	Class 21/18/15 to ISO 4406 (1999).	
Weight (Model A,B,C,D,E,F)	kg	1.00
Mounting position	optional	

Functional Symbols

Model A

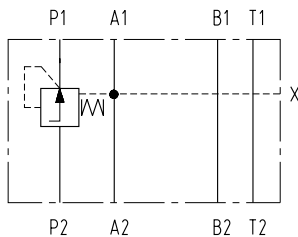

Model B

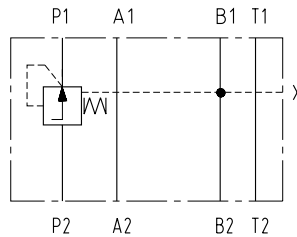

Model C

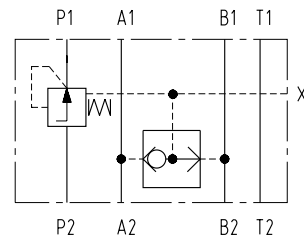

Model D

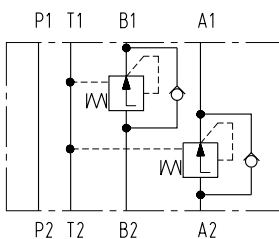

Model E

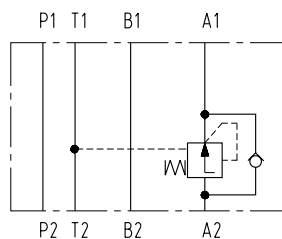

Model F

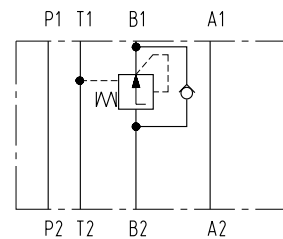

Typical applications

TV2-062/MC Meter-in compensator

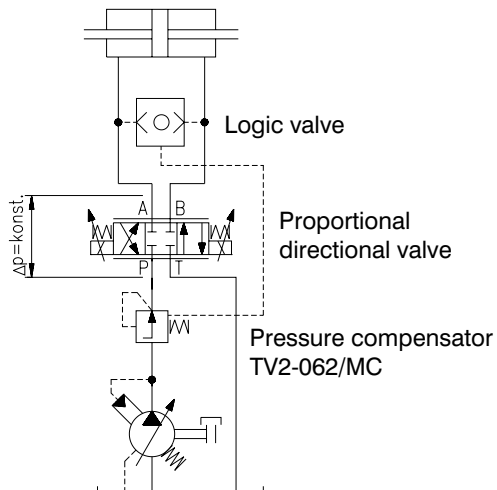

TV2-062/MD Meter-out compensator

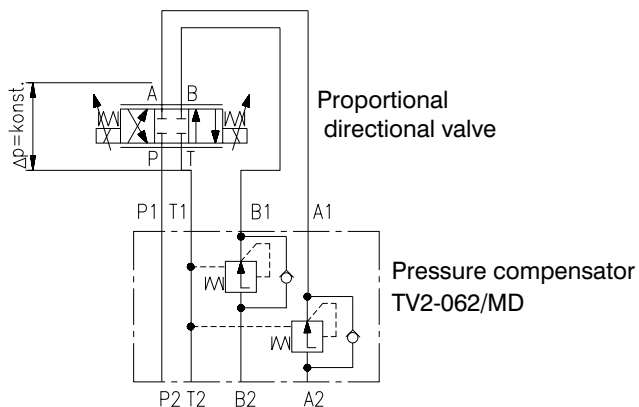

Δp-Q Characteristics

Measured at $v = 35 \text{ mm}^2/\text{s}$ and $t = 40 \text{ }^\circ\text{C}$

The characteristic of the pressure compensator corresponds to the flow rate of a PRM2-063Z11/30 proportional directional valve. By increasing the flow resistance due to a flow rate increase, also the outside pressure difference has to be increased, in order to ensure the correct control function.

TV2-062/MC Meter-in compensator

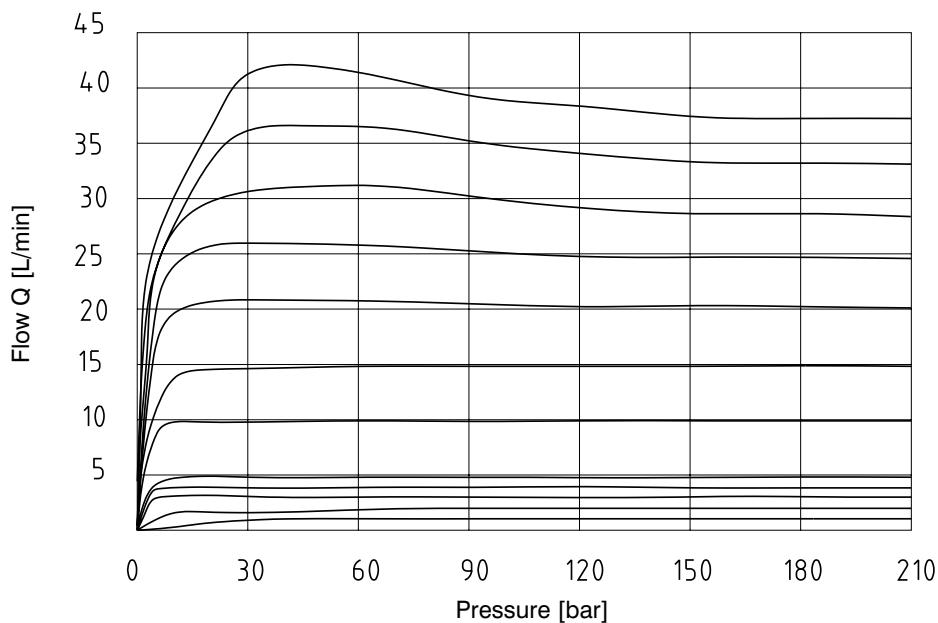

TV2-062/MD Meter-out compensator

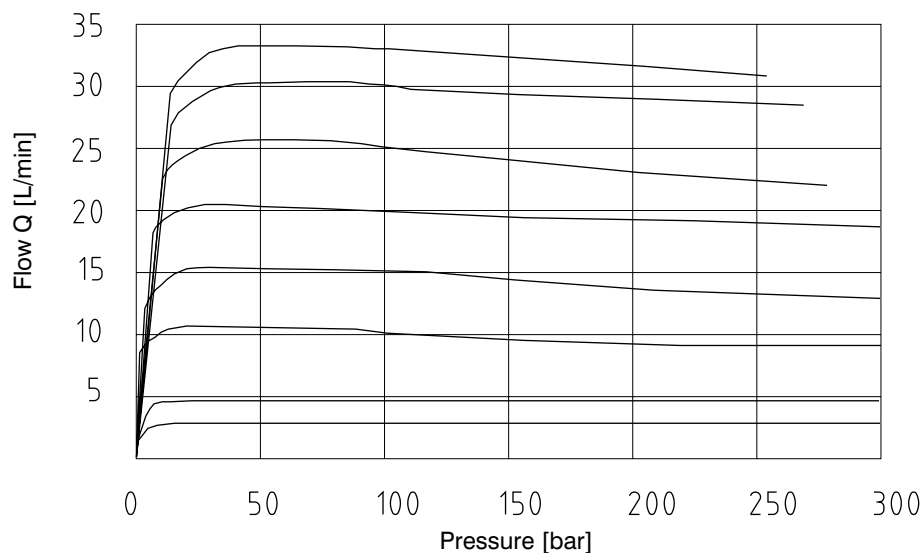

Valve Dimensions

Dimensions in millimetres

TV2-062/M Meter-in compensator

- 1 Name plate
- 2 Square ring 9.25 x 1.68 (4 pcs.)
- 3 4 mounting holes

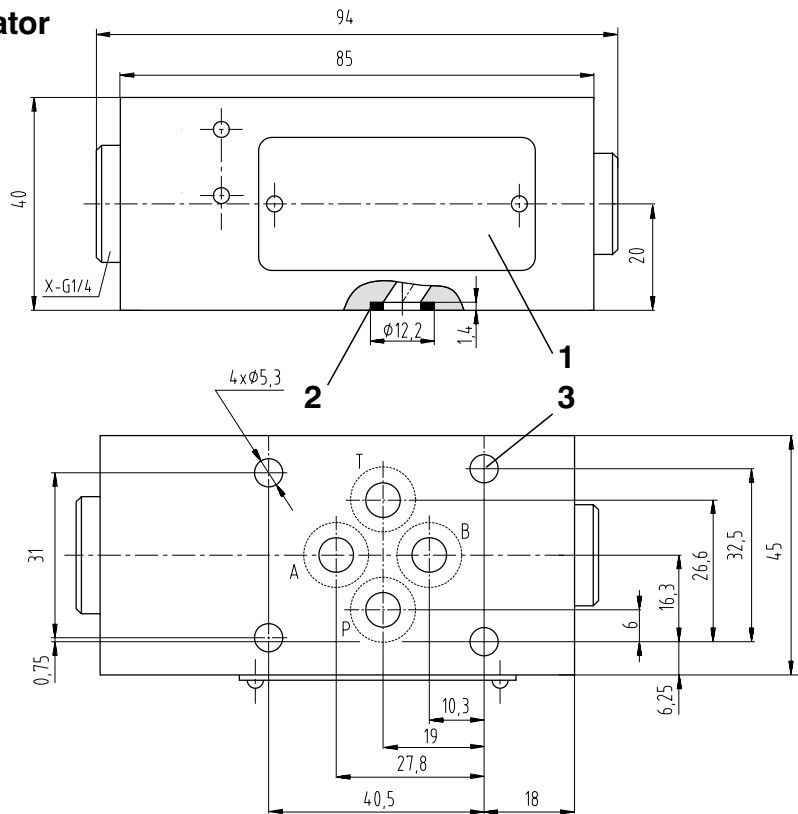

TV2-062/M Meter-out compensator

- 1 Name plate
- 2 Square ring 9.25 x 1.68 (4 pcs.)
- 3 4 mounting holes

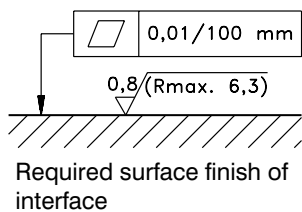
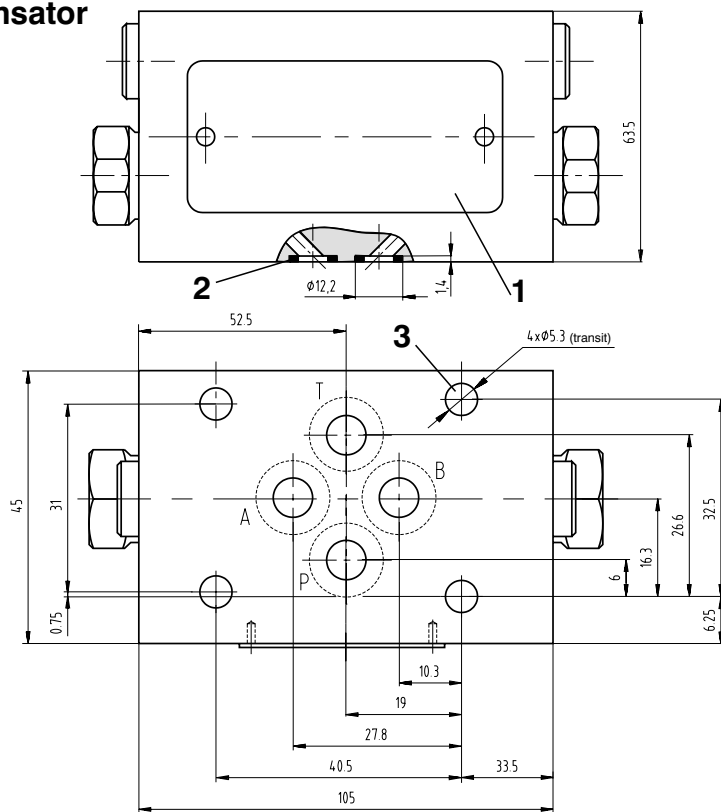

Caution!

- The packing foil is recyclable.
- The technical information regarding the product presented in this catalogue is for descriptive purposes only. It should not be construed in any case as a guaranteed representation of the product properties in the sense of the law.

ARGO-HYTOS a. s. CZ - 543 15 Vrchlábí
 Tel.: +420-499-403111, Fax: +420-499-403421
 E-mail: sales.cz@argo-hytos.com
 www.argo-hytos.com