

Technical Features

- › Direct acting, proportional control valve with integrated on-board digital electronic unit, spool position feedback and process feedback
- › Control valve with subplate mounting surface acc. to ISO 4401, DIN 24340 (CETOP 02) standards
- › The valve opening and resulting flow rate can be modulated continuously in proportion to the reference signal
- › Digital converter card allows fine control of the valve spool position, reducing hysteresis and response time and optimizing the performance of the valve
- › Various models with or without onboard digital converter card or position sensor feedback available
- › Used for directional and speed control of hydraulic actuators
- › Wide range of interchangeable spools available
- › For versions without integrated digital electronic unit wide range of solenoid electrical terminal versions available
- › The driver directly manages digital settings. It's possible to customize the settings for special applications using the optional kit.
- › In the standard version, the valve housing is phosphated and steel parts zinc-coated for 240 h protection acc. to ISO 9227
- › Enhanced surface protection for mobile sector available (ISO 9227, 520 h salt spray)

Functional Description

The proportional directional valve PRM7 consists of a cast iron housing, a special control spool, two centering springs with supporting washers, one or two proportional solenoids, a position sensor or, if desired, of a control box with digital electronics. The measurement system of the position sensor consists of a differential transformer with sensor core and its electronic evaluation unit.

Models without integrated electronic unit

The electrical connection of the solenoids is realized by a variety of connectors. The position sensor output is connected by the G4W1F connector plug. Both connectors are supplied.

In this case the proportional valve can be used as follows:

S01, S02 with the internal feedback from the spool position sensor.

Models with the integrated electronic unit

The model comprises an electronic control box that is mounted together with the position sensor on either of the solenoids. The connection of the position sensor to the control box is provided by a cable. For models with two solenoids, the solenoid mounted opposite the control box is connected to the control box by a EN 175301-803 connector.

The connection of the supply voltage, control signal, program input and external output of the position sensor is implemented in a 7-pin connector (M23). The connection of the external feedback is provided by a 5-pin connector, which also has three supply voltages +24 V, +10 V and -5 V for an external sensor available.

The solenoid coils, including the control box, can be turned in the range of $\pm 90^\circ$. The digital control unit enables the proportional valve to be controlled on the basis of data required from two feedback circuits. In this case the proportional valve can be used as follows:

- E01** Proportional directional valve
- E02*S01** Only with the internal feedback from the spool position sensor.
- E03** Only with the external feedback (pressure sensor, position sensor, etc.).
- E04*S01** With internal and external feedback.

The digital control unit utilizes pulse-width-modulation (PWM) and supplies the solenoids with current proportional to the control signal. The supply current is additionally modulated with a dither frequency. Individual functional parameters are adjusted through software by a special programmer, or by computer through the RS 232 interface. The cable kit must be ordered separately, as detailed on page 4. The correct function of the digital control unit is signaled by a green LED. The incorrect function (failure) is indicated by a red LED. As a standard, the proportional valve is delivered with factory setting.

For a model including an external feedback contact the manufacturer.

Technical Data

ISO 4401-02-01-0-05

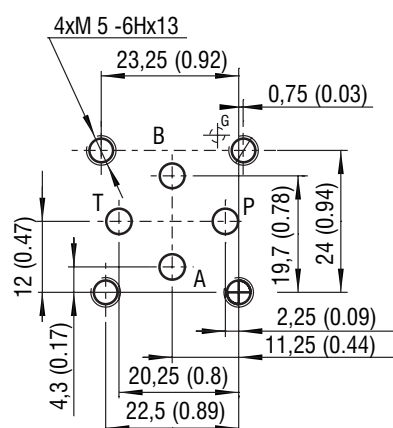

Ports P, A, B, T - max Ø4.5 mm (0.18 in)

Valve Size	04 (D02)		
Max. operating pressure at ports P, A, B	bar (PSI)	320 (4600)	
Max. operating pressure at port T	bar (PSI)	210 (3050)	
Fluid temperature range (NBR)	°C (°F)	-30 ... +80 (-22 ... +176)	
Fluid temperature range (FPM)	°C (°F)	-20 ... +80 (-4 ... +176)	
Ambient temperature max.	°C (°F)	-30 ... +50 (-22 ... +122)	
Nominal flow at Δp = 10 bar (145 PSI)	l/min (GPM)	4 (1.1)	8 (2.1) 12 (3.2)
Hysteresis	%	< 6	
Hysteresis - closed position loop	%	< 0.5	
Protection degree EN 60529		IP65	
Mass	kg (lbs)	- valve with 1 solenoid 1.5 (3.30) - valve with 2 solenoids 1.8 (3.96)	
	Data Sheet	Type	
General information	GI_0060	Products and operating conditions	
Coil types / Connectors	C_8007 / K_8008	C19B* / K*	
Mounting interface	SMT_0019	Size 04	
Spare parts	SP_8010		
Subplates	SP_0002	DP*-04	

Ordering Code

PRM7-04 / - - - - -

Proportional Directional Control Valve with Digital Control Electronics and Feedback

Valve size

Spool symbols

see the table „Spool symbols“

Nominal flow rate at Δp = 10 bar (145 PSI)

flow 4 l/min (1.1 GPM)

flow 8 l/min (2.1 GPM)

flow 12 l/min (3.2 GPM)

4

8

12

Nominal solenoid supply voltage

12V DC

24V DC

12

24

No designation

A zinc-coated (ZnCr-3), ISO 9227 (240 h)

B zinc-coated (ZnNi), ISO 9227 (520 h)

Surface treatment

standard

No designation

V

Seals

NBR

FPM (Viton)

Installation side of electronic unit and position transducer

of port A

No designation

Model

S01

position sensor with voltage outlet

S02

position sensor with current outlet

E01

proportional directional valve without feedback

E02S01

proportional directional valve with position feedback

E03

proportional directional valve with external feedback

E04S01

proportional directional valve with position and external feedback

- For proportional valves with two solenoids, one solenoid must be de-energized before the other solenoid can be charged.
- Mounting bolts M5x35 DIN 912-10.9 or studs must be ordered separately. Tightening torque is 5 Nm (3.7 lbf.ft).
- Besides the shown, commonly used valve versions other special models are available.
- Contact our technical support for their identification, feasibility and operating limits.

Spool Symbols

Type	Symbol	Type	Symbol
2Z51		3Z11	
2Z11		3Z12	
2Y51		3Y11	
2Y11		3Y12	

*Model for cylinders with asymmetric piston area ratio 1:2

Technical Data of Position Sensor - Voltage Outlet

Operating pressure	bar (PSI)	to 320 (4640), static
Electrical connection * only for S01 model		electrical connector G4W1F Hirschmann*
Contact assignment		1 - Power supply 2 - Command signal 3 - GND 4 - not used
Enclosure protection type according to EN 60529		IP65
Measured distance	mm (in)	8 (0.315)
Operating voltage	V	9.6 ... 30 DC
Linearity error	%	< 1
Current consumption at load current of 2 mA	mA	< 15
Output voltage	V	0 ... 5
Output signal range used: 0 position 1 solenoid - stroke 1.8 mm (0.07 in) 2 solenoids - stroke ±1.8 mm (0.07 in)	V	2.5 1.375 ... 2.5 1.375 ... 3.625
Max. load current	mA	2
Noise voltage - at load current 0 - at load current of 2 mA	mV _{p-p}	< 20 < 15
Additional output signal error at: - temperature change between 0 ... 80°C (32... 176 °F) - between 0... -25 °C (32 ... -13 °F) - Load change from 0 to 2 mA		typical 0.2% / 10K max. 0.5 % / 10K max. 0.5 % / 10K 0.1 %
Input voltage change from 9.6 V to 14.4 V from 14.4 V to 30 V	%	< 0.1 < 0.25
Long-term drift (30 days)	%	< 0.25
Cut-off frequency 3dB fall in amplitude Frequency 90°	Hz	> 600 > 600

Technical Data of Position Sensor - Current Outlet

Linearity	%	< 1
Operating pressure	bar (PSI)	to 320 (4640), static
Electrical connection * only for S02 model		electrical connector G4W1F Hirschmann*
Contact assignment		1 - Power supply 2 - Command signal 3 - GND 4 - not used
Enclosure protection type according to EN 60529		IP 65
Operatin voltage	V	20 ... 30 DC
Current	mA	< 35
Output signal range	mA	4 ... 20
Output signal range used: 0 position 1 solenoid - stroke 1.8mm (0.07 in) 2 solenoids - stroke ±1.8 mm (0.07 in)	mA	12 8.4 ... 12 8.4 ... 15.6
Additional output signal error: - at temperature change from +10... 55°C (50... 131°F) - at impedance change from 50% - at input voltage change in the range of operating voltage		0.2% / 10K ≤ 0.1% ≤ 0.05%
Impedance	Ω	≤ 500
Output signal ripple	mA R.M.S.	≤ 0.02
Limit frequency at 3 dB amplitude decrease	Hz	≥ 800

Technical Data of Proportional Solenoid

Type of coil	V	12 DC	24 DC
Limiting current	A	1.7	0.8
Resistance at 20° C (68 °F)	Ω	4.9	21

Electronics Data

Supply voltage with polarity inversion protection	V	11.2 ... 28 VDC (residual ripple < 10%)
Input: command signal / according to customer setting		±10 V, 0...10 V, ±10 mA, 4...20 mA, 0...20 mA, 12 mA ±8 mA
Input: spool position sensor signal		0...5V
Input: external feedback signal		0...10 V, 4...20 mA, 0...20 mA
Resolution of the A/D converter		12 bit
Output: solenoids		two PWM output stages up to max. 3.5 A
PWM frequency	kHz	18
Adjustment of parameters	μS	170
EMC	Interference resistance	61000 - 6 - 2 : 2005
	Radiation resistance	55011 : 1998 class A
Parameter setting	Serial port RS 232 (zero modem). 19200 bauds, 8 data bits, 1 stop bit, no parity. Special software PRM7 Conf.	

Accessories

Order number	Content
23093400	Connecting cable to PC - length 2 m (6.56 ft), CD-ROM with program PRM7 Conf and user manual
23093500	Connecting cable to PC - length 5 m (16.40 ft), CD-ROM with program PRM7 Conf and user manual
24523400	Connecting cable to PC - length 2 m (6.56 ft)
24523500	Connecting cable to PC - length 5 m (16.40 ft)

Frequency Response closed position loop, for E02S01 model

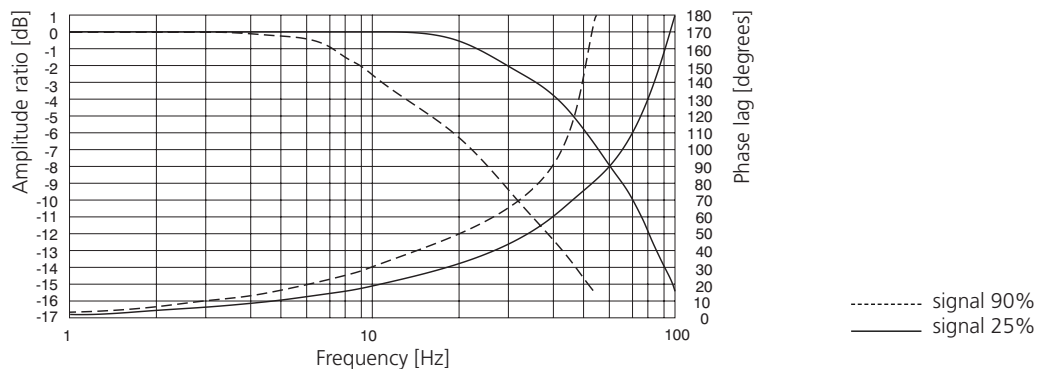

Characteristics measured at $v = 32 \text{ mm}^2/\text{s}$ (156 SUS)

Operating limits: Flow direction P → A / B → T or P → B / A → T

Operating limits only for **E01 model only**

Nominal flow 4 l/min (1.1 GPM)

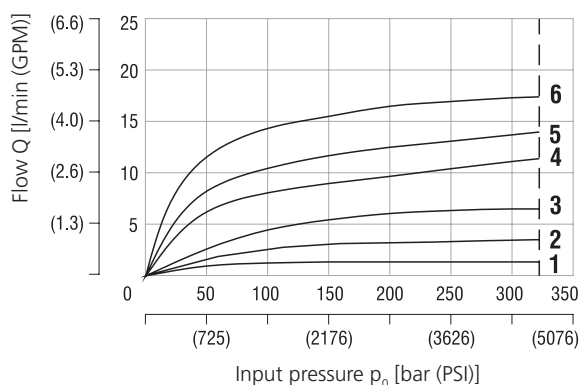

Nominal flow 8 l/min (2.1 GPM)

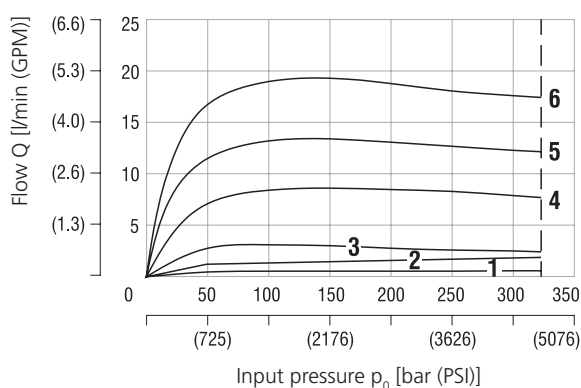

Nominal flow 12 l/min (3.2 GPM)

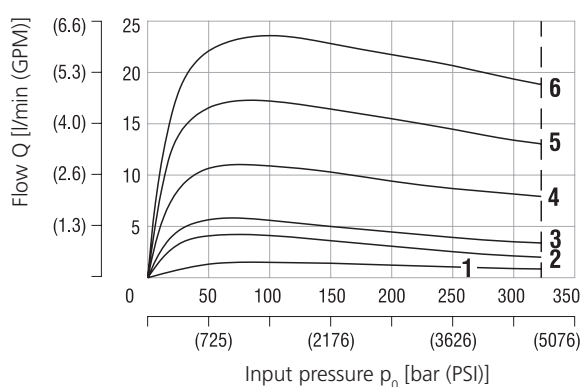

Solenoid current:

- 1 = 50%
- 2 = 60%
- 3 = 70%
- 4 = 80%
- 5 = 90%
- 6 = 100%

Regulated flow related to control signal

Flow characteristics (E01 model only) $\Delta p = 10 \text{ bar}$ (145 PSI)

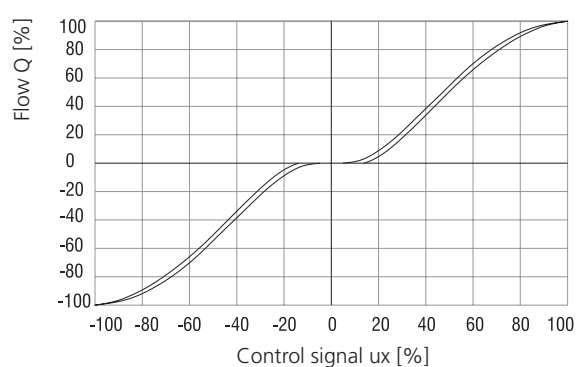

Flow Characteristics measured at $v = 32 \text{ mm}^2/\text{s}$ (156 SUS)

Flow characteristics (E02S01 model only)

$Q_n = 4 \text{ l/min}$ (1.1 GPM) by $\Delta p = 10 \text{ bar}$ (145 PSI)

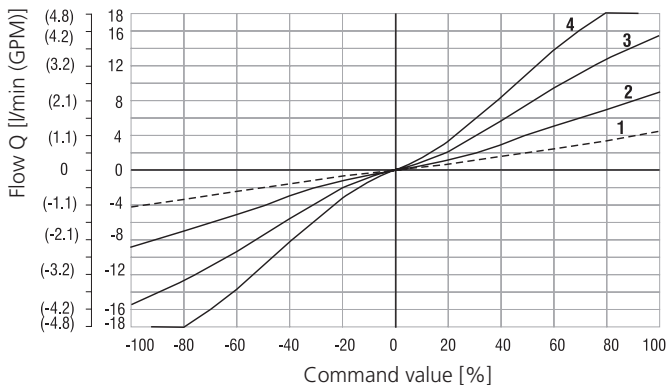

$Q_n = 8 \text{ l/min}$ (2.1 GPM) by $\Delta p = 10 \text{ bar}$ (145 PSI)

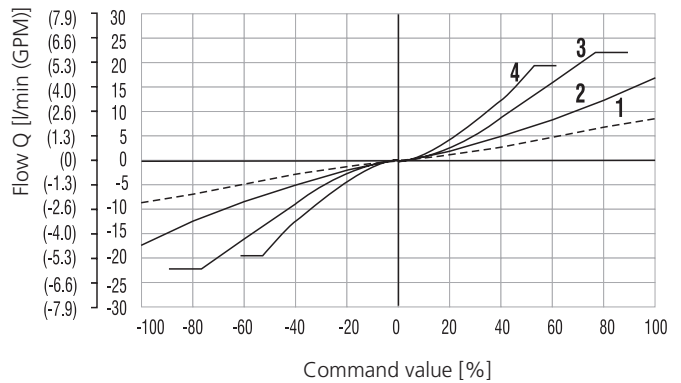

$Q_n = 12 \text{ l/min}$ (3.2 GPM) by $\Delta p = 10 \text{ bar}$ (145 PSI)

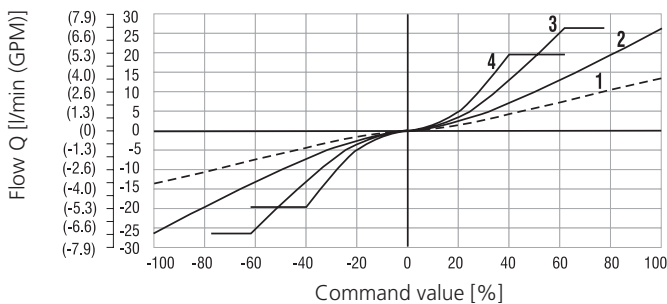

Δp = Valve pressure differential (inlet pressure p_v minus load pressure and return pressure p_r)

Δp_n = Valve pressure differential for nominal flow Q_n)

1	$\Delta p_n = 10 \text{ bar}$ (145 PSI)
2	$\Delta p = 50 \text{ bar}$ (725 PSI)
3	$\Delta p = 160 \text{ bar}$ (2321 PSI)
4	$\Delta p = 320 \text{ bar}$ (4641 PSI)

Factory Settings

Item	Model							
	E01		E02S01		E03		E04S01	
	1 Magnet	2 Magnets	1 Magnet	2 Magnets	1 Magnet	2 Magnets	1 Magnet	2 Magnets
Control signal	0 ... 10 V	$\pm 10 \text{ V}$	0 ... 10 V	$\pm 10 \text{ V}$	0 ... 10 V	$\pm 10 \text{ V}$	0 ... 10 V	$\pm 10 \text{ V}$
Signal external feedback	-		-	-	0 ... 10 V			
Output position sensor spool	-		0 ... 5 V		-		0 ... 5 V	

Connectors

K1

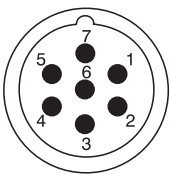

Connector K1 - type M23 (male)

PIN	Technical data
1	* Power supply input
2	* Ground (power supply)
3	Control signal
4	Ground (signal)
5	Power reference signal
6	Control signal of position sensor spool
7	* Protective earth lead (PE)

*Recommended min. lead cross section 0.75 mm^2

K2

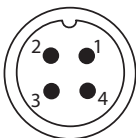

Connector K2 - type M12x1 (male)

PIN	Technical data
1	TxD
2	RxD
3	Ground (signal)
4	Not used

K3

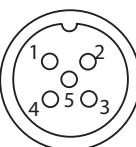

Connector K3 - type M12x1 (female)

PIN	Technical data
1	Power supply output
2	Signal of external feedback
3	Ground
4	Not used
5	Not used

K1 - Main inlet connector M23 (7PIN)
Cable diameter 8 ... 12 mm (0.31...0.47 in)

K2 - Connection RS232 M12x1 (4 PIN)
To program the electronics.

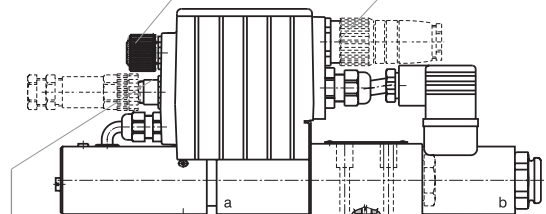

K3 - Conektor M12x1 (5PIN)
External feedback signal
(for configurations E03 and E04S01 only).

Dimensions in millimeters (inches)

PRM7-043 ... S01

PRM7-043 ... S02

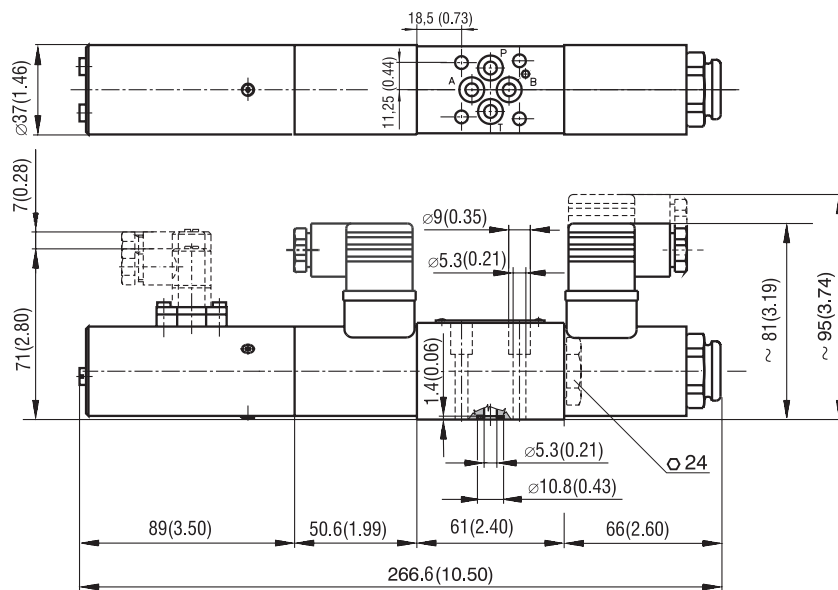

PRM7-043 ... E01 - without connector plug for spool position feedback

PRM7-043 ... E03

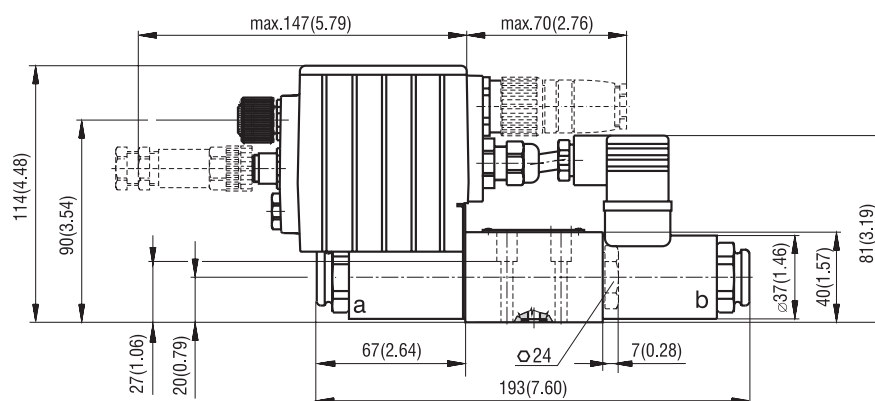

PRM7-043 ... E02S01 - without connector plug for spool position feedback

PRM7-043 ... E04S01

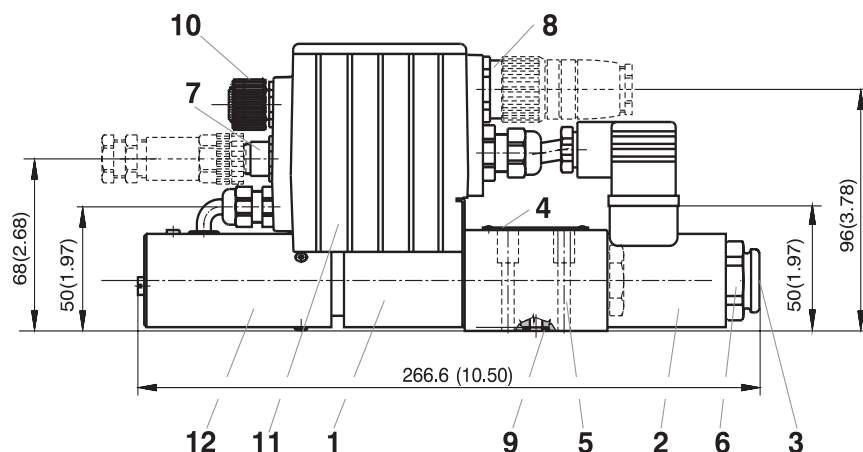

- 1 Solenoid a
- 2 Solenoid b
- 3 Manual override
- 4 Name plate
- 5 4 mounting holes
- 6 Solenoid fixing nut
- 7 Connector M12x1 for connection of external feedback
- 8 Main supply connector M23
- 9 Square ring 7.65 x 1.68 (4 pcs.), supplied in delivery packet
- 10 Cover of connector M12x1 for programming
- 11 Plastic box with integrated electronics
- 12 Position sensor