

Restrictor Valve with Reverse Flow Check, Modular

2VS3-06

Size 06 (D03) • Q_{max} 80 l/min (21 GPM) • p_{max} 320 bar (4600 PSI)



Technical Features

- › Restrictor valve with reverse flow check, mounting interface acc. to ISO 4401, DIN 24340 (CETOP 03)
- › Meter-in or meter-out flow control
- › Leak-free closing in one or two service ports
- › Linear adjustment and positive seat overlap
- › Desired settings may be locked down
- › Optionally adjustable by allen key with protective cap, or by hand screw
- › In the standard version, the valve is zinc-coated for 240 h protection acc. to ISO 9227 and the valve body is phosphated

Functional Description

Dual hydraulic flow restrictor valves with an optional by-pass check valve are used to control flow rates in two separate lines (A, B) of a hydraulic circuit. The modular design provides six functional versions. The valve restricts the fluid flow in one direction while providing free reverse flow in the opposite direction. The throttle is adjusted by a set screw, which can be operated by a key, a hand screw, or a hand screw with key lock.

The sandwich design supports stacking with other components of the same size. The separate O-ring plate provides sealing of the valve on a connecting surface. Depending on the valve installation it functions as a meter-in or meter-out flow control device. Changing the valve from meter-in to meter-out mode can be done by turning the valve by 180° around its horizontal. The orientation of the throttle check valve(s) in the valve body corresponds with the symbol on the nameplate.

Technical Data

Valve size	06 (D03)	
Max. flow	l/min (GPM)	80 (21.1)
Max. operating pressure	bar (PSI)	320 (4640)
Fluid temperature range (NBR)	°C (°F)	-30 ... +100 (-22 ... 212)
Fluid temperature range (FPM)	°C (°F)	-20 ... +120 (-4 ... 248)
Mass	kg (lbs)	1.2 (2.65)

	Datasheet	Type
General information	GI_0060	Products and operating conditions
Mounting interface / tolerances	SMT_0019	ISO 4401-03-02-0-05 DIN 2430 (CETOP 03)
Spare parts	SP_8010	

ISO 4401-03-02-0-05

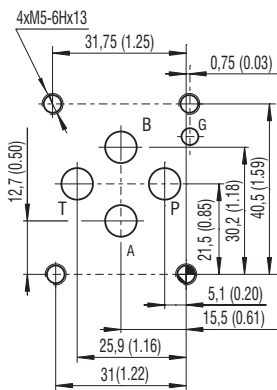

Ports P, A, B, T - max \varnothing 7.5 mm (0.29 in)

Characteristics measured at $v = 32 \text{ mm}^2/\text{s}$ (156 SUS)

Pressure drop related to flow rate

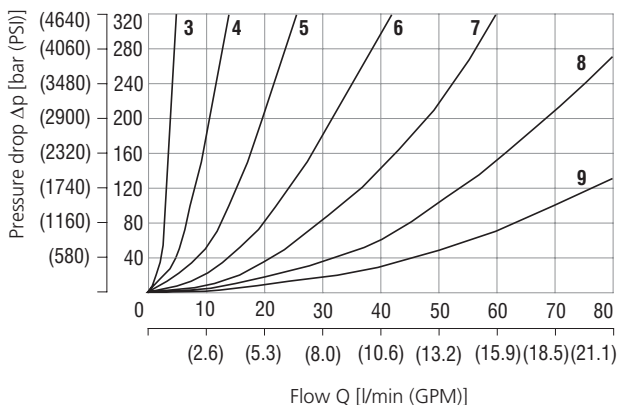

Number of turns of the adjustment screw						
3	4	5	6	7	8	9

Check valve pressure drop related to flow rate

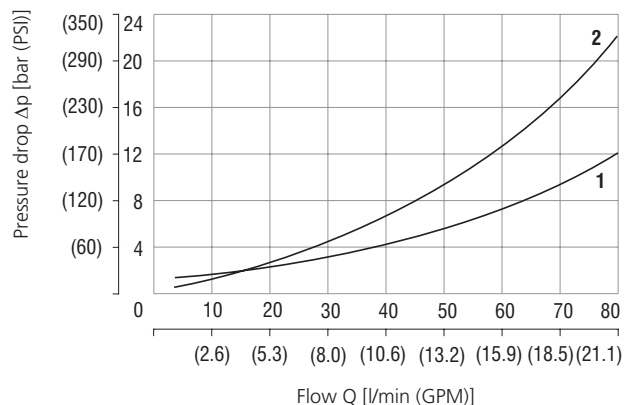

Throttle valve closed	Throttle fully open
1	2

Dimensions in millimeters (inches)

Model 2VS3-06-C*

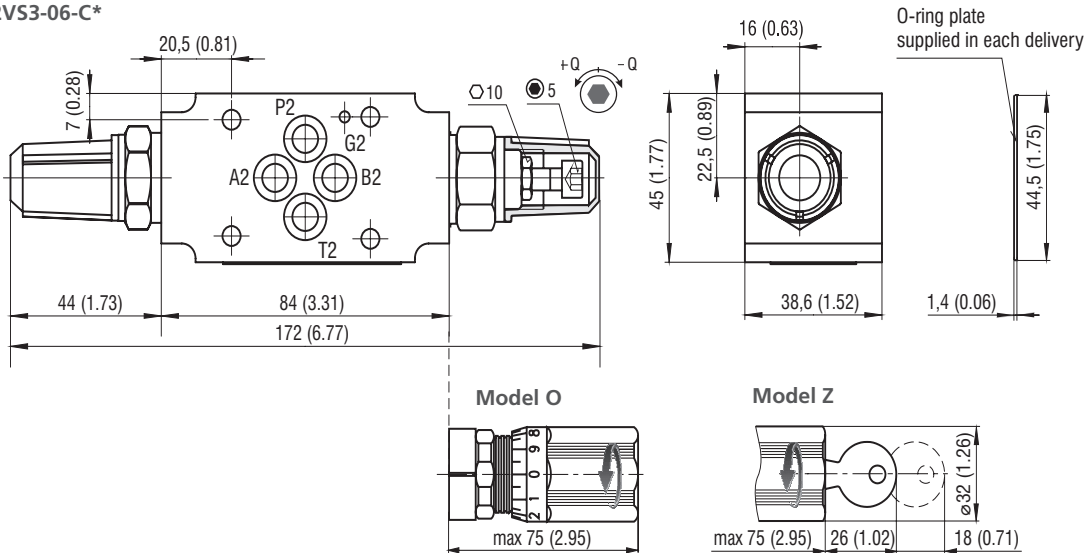

Model 2VS3-06-A*

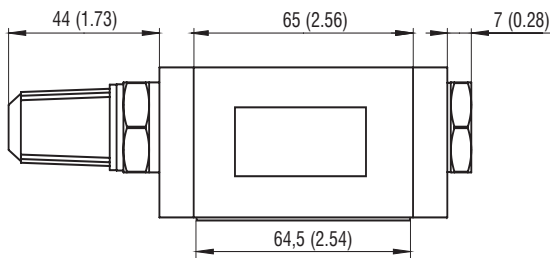

Model 2VS3-06-B*

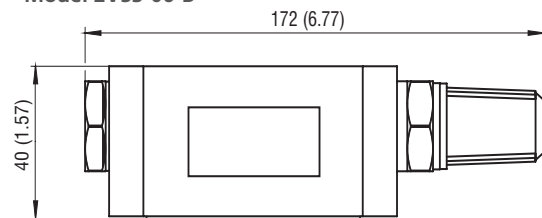

Functional Symbols

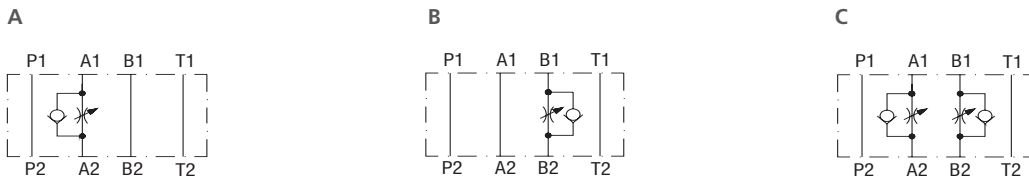

Notice: The orientation of the symbol on the name plate corresponds with the valve function.

With the separate O-ring plate the valve body may be mounted 180° rotated, which changes the valve function from meter-in to meter-out.

Ordering Code

2VS3 - 06 - -

Restrictor valve with reverse flow check, modular

Valve size

Functional symbols

check valve in line A, meter-in*
check valve in line B, meter-in*
check valve in line A and B, meter-in*

A
B
C

No designation

A
B

Surface treatment
body phosphated, steel parts
zinc-coated (ZnCr-3), ISO 9227 (240 h)
zinc-coated (ZnCr-3), ISO 9227 (240 h)
zinc-coated (ZnNi), ISO 9227 (520 h)

No designation

V

Seals
NBR
FPM (Viton)

Adjustment option

allen key (hex. 5), without protective cap
allen key (hex. 5), with protective cap
non-lockable cylindrical hand screw
lockable cylindrical hand screw

*see table of functional symbols

Changing the valve's function from meter-in to meter-out is accomplished by mounting the valve rotated 180° around its horizontal axis.