

Technical Features

- › Directional control valve, internally or externally pilot operated with mounting interface acc. to ISO 4401, DIN 24340 (CETOP 08)
- › Driven by an ISO 4401-03 (CETOP 03) solenoid operated directional valve (RNEH) or a hydraulic pilot operated directional valve (RNH)
- › Electrohydraulic and hydraulic control ports X and Y
- › Version for high pressures 420 bar (6090 PSI) available
- › High transmitted hydraulic power, optimized design to minimize the pressure drop
- › Flexibly changed from internal pilot or drain to external by inserting or removing threaded plugs in the main control valve body
- › Wide range of interchangeable spools and valve controls available
- › Soft-shift, spool speed, main stroke limiter control options
- › In the standard version the valve body is phosphated and operating solenoids are zinc coated for 240 h corrosion protection in NSS acc. to ISO 9227
- › Enhanced surface protection for mobile sector for up to 520h salt spray acc to ISO 9227

ISO 4401-08-08-0-05

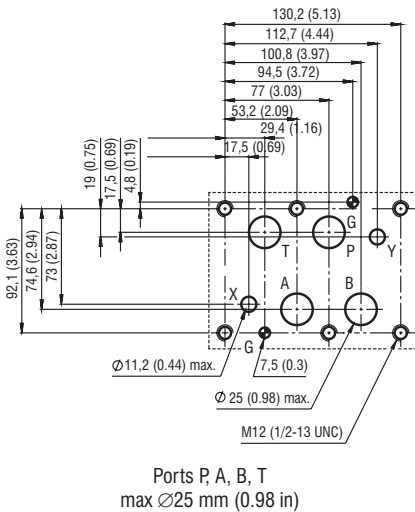

Technical Data

Valve type		RN*4-25	RN*4H-25
Valve size		25 (D08)	
Max. flow		600 (159)	
Max. operating pressure at port P, A, B		320 (4640)	420 (6090)
- at port T (external drain)		210 (3050)	350 (5080)
- at port T (internal drain)		210 (3050)	
Minimum pilot pressure		12 (174)	
Maximum pilot pressure		210 (3050)	
Fluid temperature range (NBR)		-30 ... +80 (-22 ... +176)	
Fluid temperature range (FPM)		-20 ... +80 (-4 ... +176)	
Ambient temperature range		-30 ... +50 (-22 ... +122)	
Supply voltage tolerance		AC: \pm 10	DC: \pm 10
Max. switching frequency		10 000	
Enclosure type acc.to EN 60529		IP 65	
Switching time at $v=32$ mm ² /s (156 SUS)	ON	AC: 45 ... 60	DC: 55 ... 75
	OFF	AC: 60 ... 90	DC: 60 ... 90
Mass	RNH4-25	13.2 (29.1)	
	RNEH4-252	15 (33.1)	
	RNEH4-253	15.6 (34.4)	
Data Sheet		Type	
General information		GI_0060	
Mounting interface / tolerances		SMT_0019	
Spare parts		SP_8010	
		Products and operating conditions	
		Size 25	

Characteristics measured at $v = 32$ mm²/s (156 SUS)

Operating limits

Operating limits for maximum hydraulic power at rated temperature and supplied with voltage equal to 90% of the nominal value

Maximum flow rates in l/min (GPM)	at pressure	
	210 bar (3050 PSI)	320 bar (4640 PSI)
Spool type C11	500 (133)	450 (119)
All other spools	600 (159)	500 (133)

Pressure drop related to flow rate

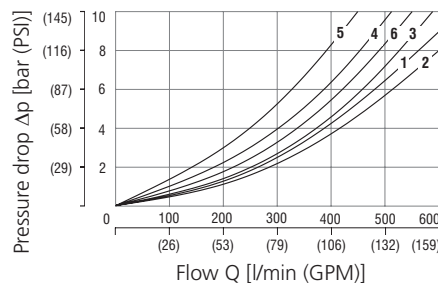

Pressure drop related to flow rate

Back pressure valve incorporated on line P

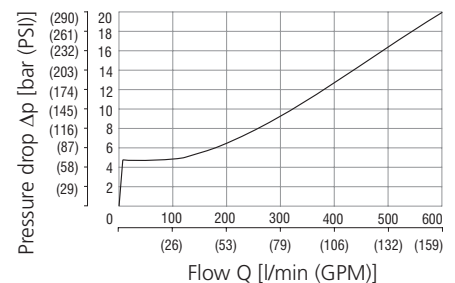

	Spool position	P-A	P-B	A-T	B-T	P-T
Z11, J17, J27	Energized	1	1	2	3	
H11	De-energized					6*
	Energized	5	5	1	2	
Y11	De-energized			4**	4***	
	Energized	1	1	1	2	
C11	De-energized					6
	Energized	6	6	3	4	
R51, R52, X51, X52	De-energized		1	2		
	Energized	1	1	2	3	

* A-B blocked ** B blocked *** A blocked

The curve refers to the pressure drop (body part only) with back pressure valve energized to which the pressure drop of the reference spool must be added.

Ordering Code

4/2 and 4/3 directional control valve, internally and externally pilot operated		Surface treatment standard A zinc-coated (ZnCr-3), ISO 9227 (240 h) B zinc-coated (ZnNi), ISO 9227 (520 h)	
Actuation electrohydraulic hydraulic		Seals NBR V FPM (Viton)	
Design series standard 320 bar high pressure 420 bar (not available for C11 spools)		Manual override (only for RNEH) standard N1 protected with retaining nut N2 protected with rubber boot	
Valve size ISO 4401-08-08-0-05 (CETOP 08)		Solenoid electrical terminals EN 175301-803-A E1 E1 with quenching diode E2 EN 175301-803-A with integrated rectifier E5	
Number of valve positions two positions three positions		Rated supply voltage of solenoids (at the coil terminal) 01200 12 V DC / 2.72 A 02400 24 V DC / 1.29 A 12060 120 V AC / 0.35 A / 50 (60) Hz 23050 230 V AC / 0.17 A / 50 (60) Hz	
Spool symbols see the table „Spool Symbols“		see data sheet RPE3-06 (4010) for other pilot valve options	
Control Options without additional features main spool stroke limiter main spool shifting speed control shifting speed control, with orifice (0.8 mm) in port P of solenoid pilot valve		Check valve incorporated in P-line none C3 with back pressure check valve	
Piloting internal, not available for spools 3H11, 3C11, 2X52, 2R52, 2J27, if internal pilot is required, choose „internal piloting with check valve C3“ internal with installed pressure reducing valve VRP2-06, fixed 30 bar setting external		Drain external, internal	

Installation Note:

- It is necessary to ensure minimum pilot pressure, that is why either external piloting or option C3 (check valve in P port) must be used for spools which have connection between P and T ports (H11, C11, R52, X52, J27). In this case, the valve must be externally drained.
- Attention: spools J17, J27 may assume an undefined position without energy supply.
- For directional valves with two solenoids, one solenoid must be de-energized before the other solenoid can be energized.
- The AC coils correspond to E5 solenoid electrical terminal.
- For other solenoid voltages see data sheet HA 8007.
- The solenoid operated valves are delivered without connectors. For connectors see data sheet HA 8008.
- Configurations with centering and recall springs can be mounted in any position; J17, J27 valves - without springs or mechanical retention - must be mounted with the longitudinal axis in the horizontal.
- Other special versions are available. Consult our technical department.

Spool Symbols

Three positions with centering spring		Two positions with return spring	
Z11		R51	
H11		R52	
Y11		X51	
C11		X52	
P11		Two positions with mechanical detent on pilot valve	
Symbols are referred to the solenoid valve RNEH. For the hydraulic control version RPH please see the connection schematic (see page 3)		J17	
		J27	

Pilot and Drain

The RNEH valves are available with pilot and drain, both internal and external. The version with external drain allows for a higher back pressure on the outlet.

Type of valve		Plug assembly	
		X	Y
RNEH4-25**/***	internal pilot and external drain	NO	YES
RNEH4-25**/**I	internal pilot and internal drain	NO	NO
RNEH4-25**/*E*	external pilot and external drain	YES	YES
RNEH4-25**/*EI	external pilot and internal drain	YES	NO

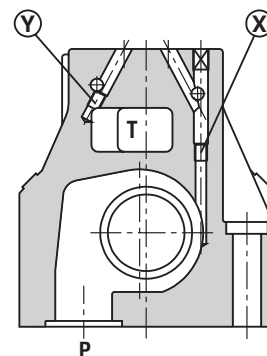

X: plug M6x8 for external pilot
Y: plug M6x8 for external drain

Check Valve incorporated in Line P

Valves RNEH are available with a back pressure valve incorporated on line P (Type „C3“). This is necessary to obtain the piloting pressure when the control valve (in the rest position) has the line P connected to the port T (spools H11, C11, R52, X52, J27). The cracking pressure is 5 bar with a minimum flow rate of 15 l/min.

Add „C3“ to the identification code for this request (see „Ordering Code“ section).

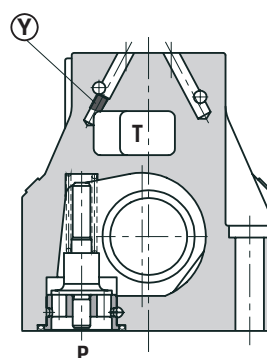
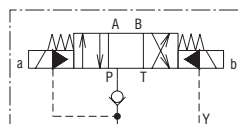

pilot always internal

Y: plug M6x8 for external drain



In the C3 version the piloting is always internal. The back pressure valve can't be used as a check valve because it doesn't guarantee sealing.

The back pressure valve can be also delivered separately and it can be easily mounted on line P of the main control valve. Specify the code to order the back pressure valve separately from the spare part data sheet No. 8010.

Electrical Features

Solenoids

The operating solenoids are DC solenoids. For AC supply, the solenoids are provided with a rectifier integrated in the DIN connector socket as part of the solenoid. The connectors can be turned by 90°. By loosening the nut, the solenoids can be turned or replaced without interfering with any seals of the valve. In case of a solenoid malfunction or power failure, the spool of the valve can be shifted by manual override, provided the pressure in port T does not exceed 25 bar.

For detail information on the pilot valve RPE3-06 refer to data sheet No.4010.

Actuation in millimeters (inches)

Solenoid control: RNEH

The valve is supplied with an RPE3-06 pilot solenoid valve.

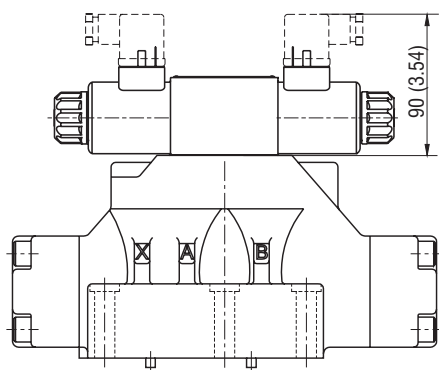

Hydraulic control: RNH

The valve is supplied with a cross-connection cover plate. X and Y connections are used for the hydraulic control of the valve.

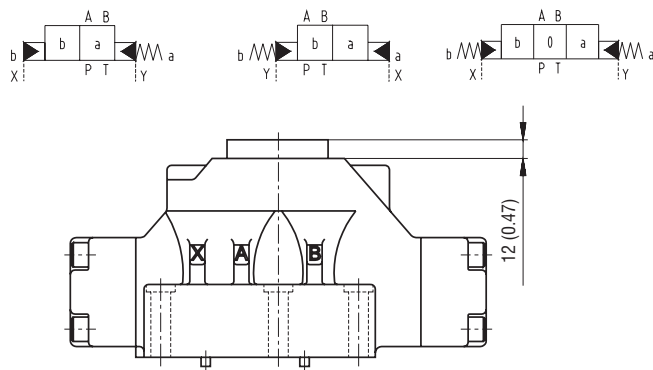

The minimum piloting pressure can be as low as 5 bar at low flow rates, but with higher flow rates a pressure of 12 bar is needed.

If the valve operates with higher pressures it is necessary to use the version with external pilot and reduced pilot pressure. Otherwise, the valve with internal pilot and a pressure reducing valve with a 30 bar fixed setting can be ordered.

Control Options - Special Features

Control of the main spool shifting speed: D

By placing a 2VS3-06 flow control valve between the pilot solenoid valve and the hydropiloted valve, the pilot flow rate can be controlled and therefore the shifting speed adjusted. Add the letter **D** to the identification code to request this device.

Pilot pressure reducing valve - 30 bar fixed setting: Z

Internal piloting with mounted pressure reducing valve VRP2-06 with 30 bar fixed setting. The option **Z** may be used together with option **D**.

Control of the main spool stroke: C

Using special side plugs, it is possible to introduce stroke control the piloted valve so as to vary the maximum spool opening clearance. This solution allows the control of the flow rate from the pump to the actuator and from the actuator to the outlet, resulting in double adjustable control of the actuator. Add the letter **C** to the identification code to request this device.

Shifting speed control: PF

with an orifice (0.8 mm) in port P of the solenoid pilot valve
Add **PF** to the identification code to request this device

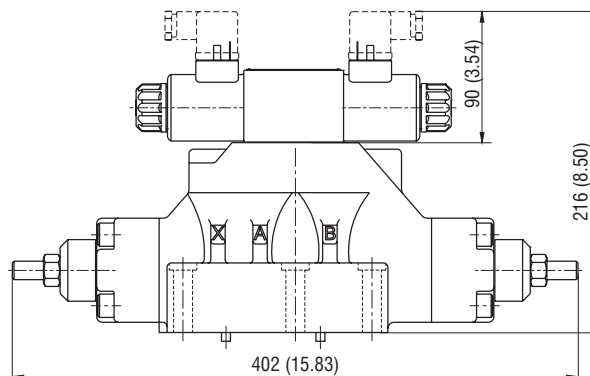
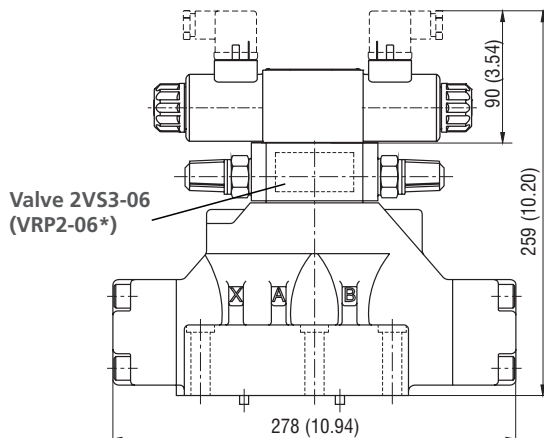

Solenoid operated distributor with pilot valve in configuration 3H11

It is possible to deliver the solenoid operated distributor with the pilot valve in configuration 3H11 (all the ports at the outlet). This configuration is used with external piloting in order to allow the unloading of the piloting line when the solenoid operated valve is in the rest position. With this option, the piloting is necessarily external.

Dimensions in millimeters (inches)

RNEH4-252, RNEH4-253

