

Technical features

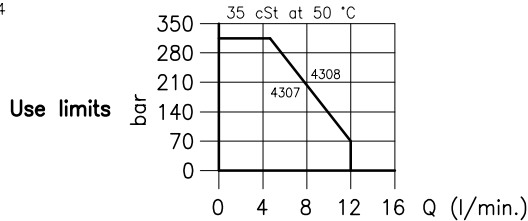

Cavity	(For dimensions see catalogue 17.000)	S 20/4
Max. flow	(l/min.)	12
Max. pressure way 1-2-3	(bar)	315
Max. pressure way 4	(bar)	50
Max. leakage	(cm ³ /min.)	20
Response time	(ms)	20 - 40
It change in function of circuit, pressure, flow and fluid viscosity.		(Mean value)
Fluid viscosity range	(cSt)	2.8 - 380
Fluid temperature range	(°C)	-20 +80
Mass	(kg)	0.170
Hydraulic fluid; mineral oil HM and HV		ISO 6074
Recommended filtration; 19/15 ISO 4466 (25 μ absolutes)		
Standard seals in Polyurethane and Buna N		

Dimensions

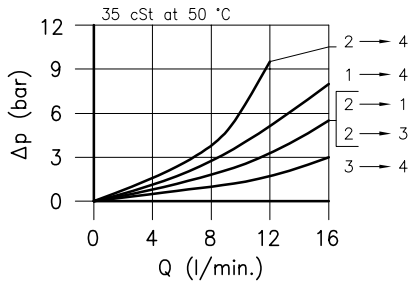
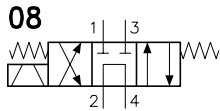
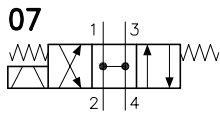
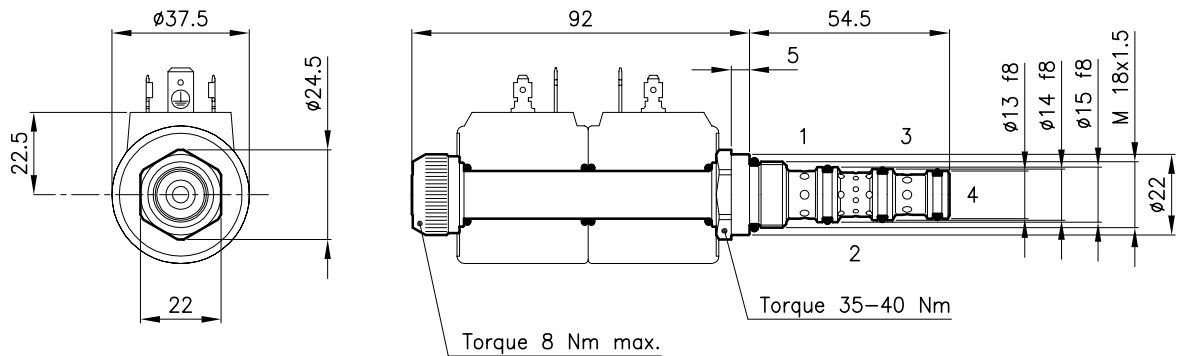

Ordering informations

ETD 20/4307

ETD 20/43.. = Valve type
Centre open

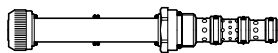

Circuits

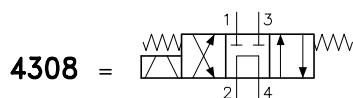
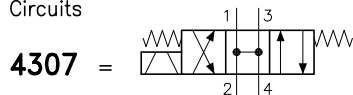

Codes:

ETD 20/4307	25 011 127
ETD 20/4308	25 011 128
External seals kit	90 620 102

ETD 20/43.. valves can be assembled on standard bodies 20-C4 serie; for dimensions see catalogue 16.011

On the ETD 20 valves must be assembled the Coils B20 series; for dimensions, features and codes see catalogues 09.900 and 09.901.