

Technical features

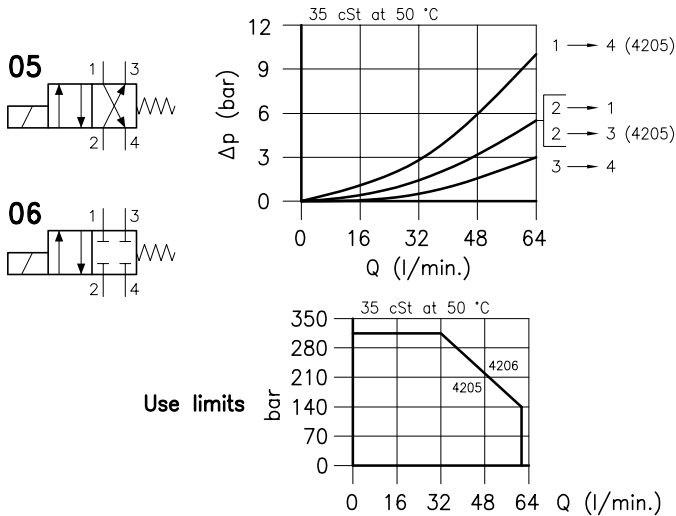

Cavity	(For dimensions see catalogue 17.000)	S 50/4
Max. flow	(l/min.)	60
Max. pressure way 1-2-3	(bar)	315
Max. pressure way 4	(bar)	210
Max. leakage	(cm ³ /min.)	40
Response time	(ms)	40 - 80
It change in function of circuit, pressure, flow and fluid viscosity.		(Mean value)
Fluid viscosity range	(cSt)	2.8 - 380
Fluid temperature range	(°C)	-20 +80
Mass	(kg)	0.480
Hydraulic fluid; mineral oil HM and HV		ISO 6074
Recommended filtration; 19/15 ISO 4466 (25 μ absolutes)		
Standard seals in Polyurethane and Buna N		

Dimensions

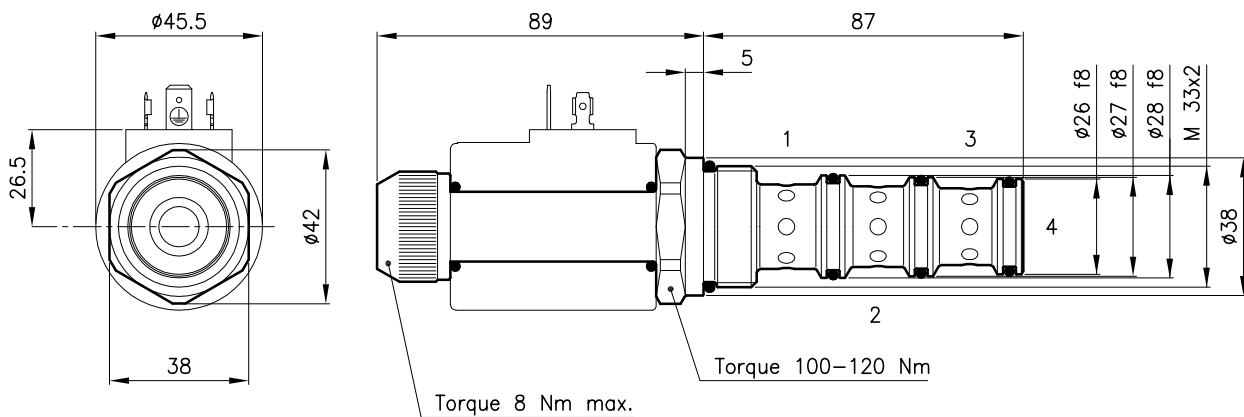

Ordering informations

ETD 50/4205

ETD 50/42.. = Valve type
Centre closed

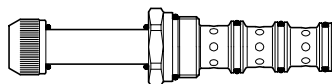

Circuits

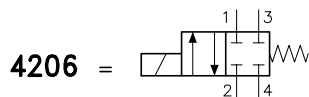
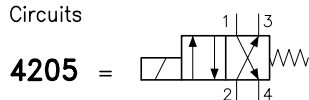

Codes:

ETD 50/4205	55 011 118
ETD 50/4206	55 011 123
External seals kit	90 620 108

ETD 50/42.. valves can be assembled on standard bodies 50-C4 series; for dimensions see catalogue 16.011

On the ETD 50 valves must be assembled the Coils B50 series; for dimensions, features and codes see catalogues 09.900 and 09.901.