

**Technical features**

**01**

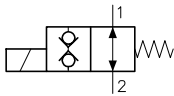

**01-MO**

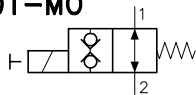

**02**

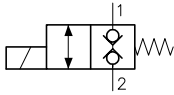

**02-MO**

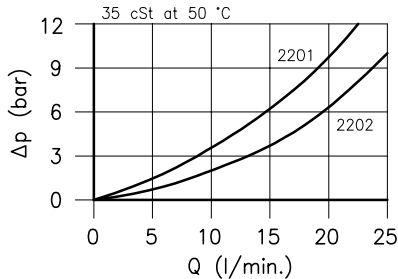
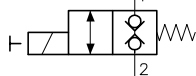

Cavity	(For dimensions see catalogue 17.000)	S 30/2
Max. flow	01/01-MO (l/min.)	20
Max. flow	02/02-MO (l/min.)	25
Max. pressure	(bar)	315
Response time	(ms)	30 - 60
It change in function of circuit, pressure, flow and fluid viscosity.		(Mean value)
Fluid viscosity range	(cSt)	2.8 - 380
Fluid temperature range	(°C)	-20 +80
Mass	(kg)	0.210
Hydraulic fluid; mineral oil HM and HV ISO 6074		
Recommended filtration; 19/15 ISO 4466 (25 μ absolutes)		
Standard seals in Polyurethane and Buna N		

**Dimensions**

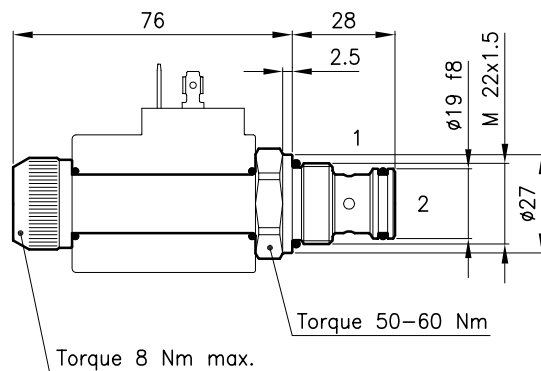
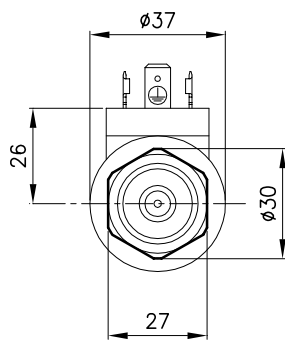

**Ordering informations**

**ECD 30/2202-MO**

ECD 30/22.. = Valve type

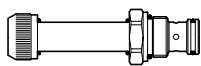

Circuits

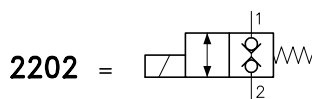
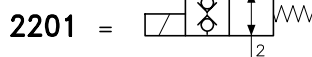

**MO** = Manual override  
(Omit if not request)

Codes:

ECD 30/2201	35 011 129
ECD 30/2201-MO	35 011 145
ECD 30/2202	35 011 117
ECD 30/2202-MO	35 011 131
External seals kit	90 620 103

ECD 30/22.. valves can be assembled on standard bodies 30-LO series; for dimensions see catalogue 16.010

On the ECD 30 valves must be assembled the Coils B30 series; for dimensions, features and codes see catalogues 09.900 and 09.901.